

Article number: 03010040

Description: Fluro Rod End GASW 40
Zinc Plated

Measures

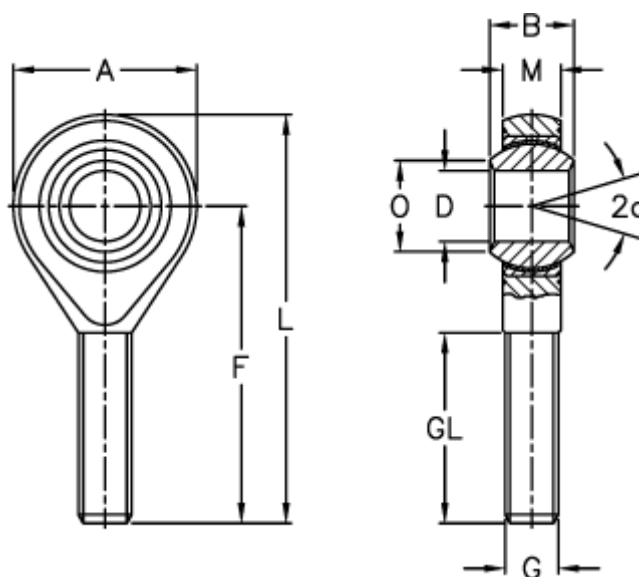

A	= 90	L	= 187
a (degrees)	= 16	M	= 35
B	= 49	O	= 44.2
D	= 40	Permissible rpm	= 100
Dynamic load C (kN)	= 286	Static load C0 (kN)	= 124
F	= 142	Weight (g)	= 2570
g	= M42x2		
GL	= 78		